

IR Receiver Modules for Remote Control Systems

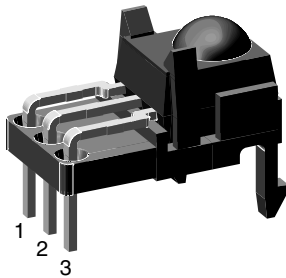

16644

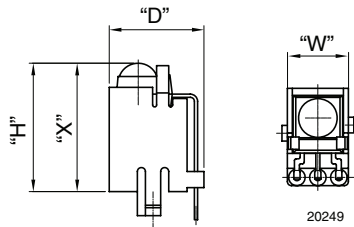

20249

FEATURES

- Compliant to RoHS directive 2002/95/EC and in accordance to WEEE 2002/96/EC



AVAILABLE FOR:

- TSOP34...
- TSOP4....
- TSOP32...
- TSOP2....



RoHS
COMPLIANT

NAME	LENS AXIS (X)	VIEW	TYPE	HEIGHT (H)	WIDTH (W)	DEPTH (D)
LL1	7.2	Top	Holder	7.2	7.4	14

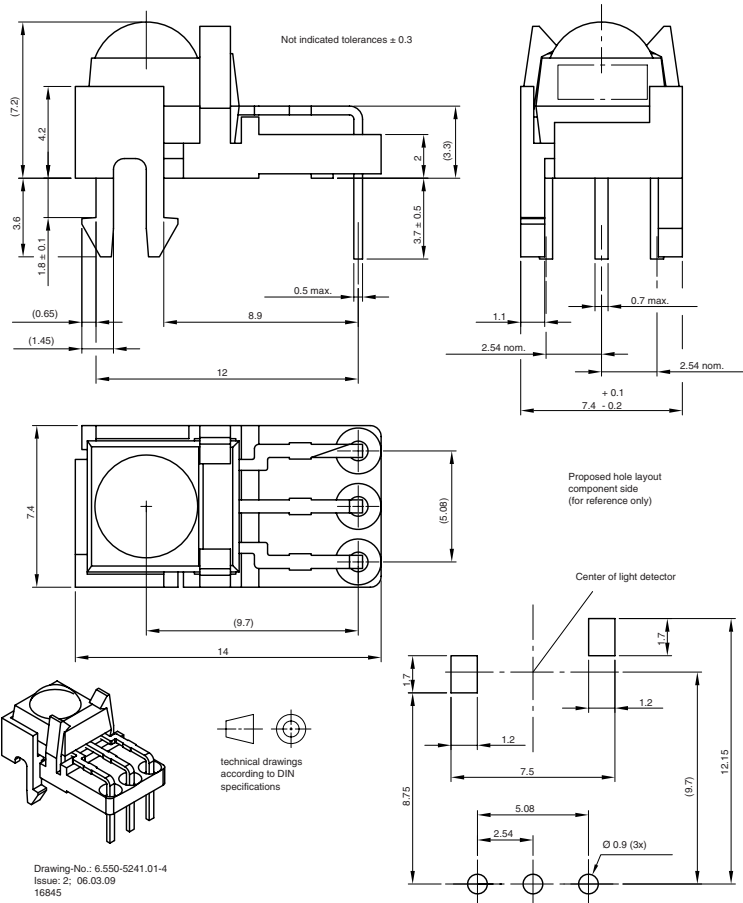
MECHANICAL DIMENSIONS in millimeters

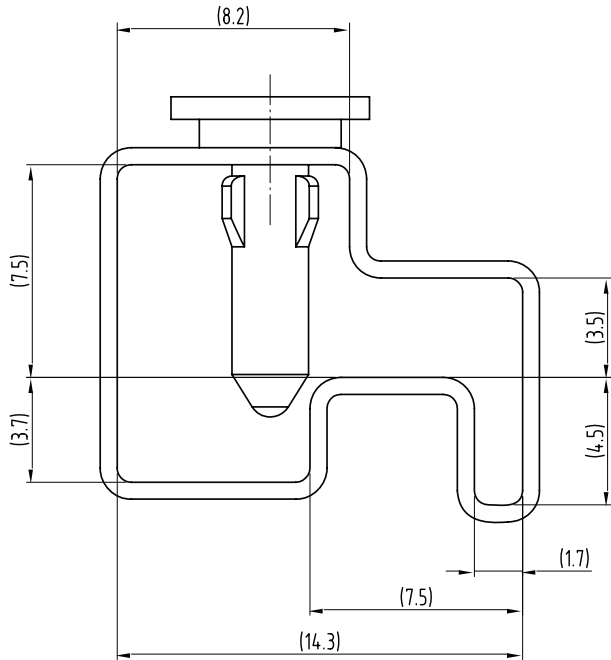

PACKAGING DIMENSIONS in millimeters



Wanddicke/wall thickness: 0.6
Bohrungen durchgehend
holes on both sides

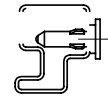
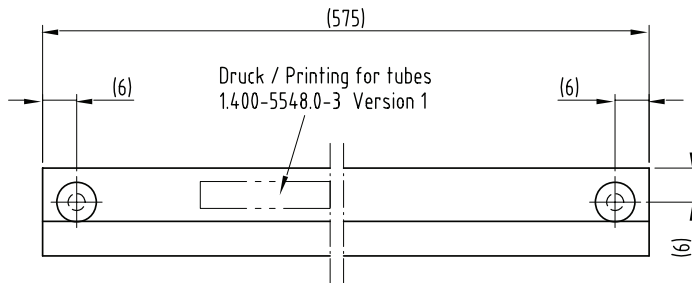

Drawing-No.: 9.700-5258.0-4
Rev. 2; Date: 20.11.03
20317-1

1:1

ORDERING INFORMATION

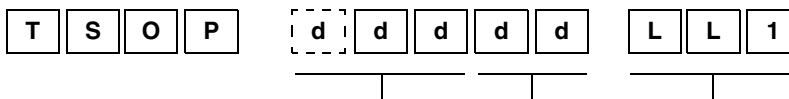

2 or 3 digit product series 2 digit frequency Holder type

Note

d = "digit", please consult the list of available series on the previous page to create a valid part number.

Example: TSOP14838LL1

PACKING QUANTITY

- 75 pieces per tube
- 40 tubes per carton